

GCSE Mathematics

Practice Tests: Set 6

Paper 3H (Calculator)

Time: 1 hour 30 minutes

You should have: Ruler graduated in centimetres and millimetres, protractor, pair of compasses, pen, HB pencil, eraser, calculator. Tracing paper may be used.

Instructions

- Use **black** ink or ball-point pen.
- **Fill in the boxes** at the top of this page with your name, centre number and candidate number.
- Answer **all** questions.
- Answer the questions in the spaces provided – *there may be more space than you need.*
- **Calculators may be used.**
- Diagrams are NOT accurately drawn, unless otherwise indicated.
- You must **show all your working out.**



Information

- The total mark for this paper is 80
- The marks for **each** question are shown in brackets – *use this as a guide as to how much time to spend on each question.*

Advice

- Read each question carefully before you start to answer it.
- Keep an eye on the time.
- Try to answer every question.
- Check your answers if you have time at the end.

Answer ALL questions.

Write your answers in the spaces provided.

You must write down all the stages in your working.

1. Here is a rectangle.

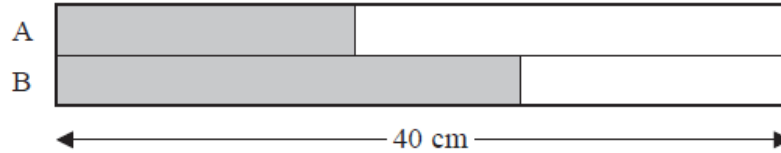

The rectangle has been divided into two strips, A and B.
The strips have the same width.

$\frac{2}{5}$ of strip A is shaded.

$\frac{5}{8}$ of strip B is shaded.

The length of the rectangle is 40 cm.

What fraction of the rectangle is **not** shaded?

.....
(Total 4 marks)

2. Make w the subject of the formula $P = \frac{w-3}{2}$

.....
(Total 2 marks)

3.

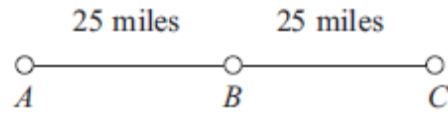

A, *B* and *C* are 3 service stations on a motorway.

$AB = 25$ miles

$BC = 25$ miles

Aysha drives along the motorway from *A* to *C*.

Aysha drives at an average speed of 50 mph from *A* to *B*.

She drives at an average speed of 60 mph from *B* to *C*.

Work out the difference in the time Aysha takes to drive from *A* to *B* and the time Aysha takes to drive from *B* to *C*.

Give your answer in minutes.

..... minutes

(Total 3 marks)

4. Solve the simultaneous equations

$$4x + 3y = -7$$

$$3x - 4y = 26$$

$x =$

$y =$

(Total 4 marks)

5. Toby invested £4500 for 2 years in a savings account.
He was paid 4% per annum compound interest.

(a) How much did Toby have in his savings account after 2 years?

£
(3)

Jaspir invested £2400 for n years in a savings account.
He was paid 7.5% per annum compound interest.

At the end of the n years he had £3445.51 in the savings account.

(b) Work out the value of n .

.....
(2)

(Total 5 marks)

6. Here is a shape.

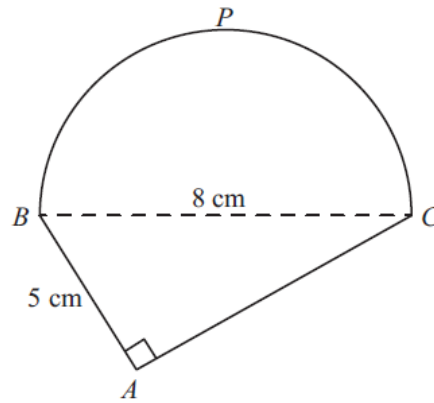

BPC is a semicircle.

BAC is a right-angled triangle.

$BC = 8$ cm.

$AB = 5$ cm.

Work out the perimeter of the shape.

Give your answer correct to 3 significant figures.

..... cm

(Total 5 marks)

7. The diagram shows a trapezium.

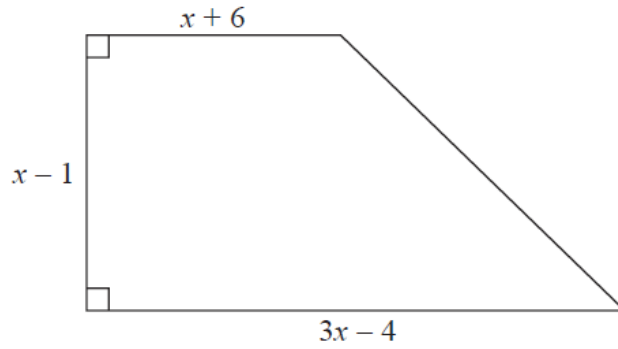

Diagram **NOT** accurately drawn

All measurements on the diagram are in centimetres.

The area of the trapezium is 119 cm^2

(i) Show that $2x^2 - x - 120 = 0$

(ii) Find the value of x .
Show your working clearly.

$x = \dots\dots\dots$

(Total 6 marks)

8. Here is a number line.

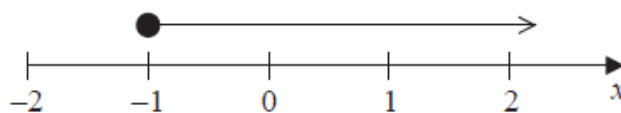

(a) Write down the inequality shown on the number line.

.....
(1)

p is an integer.

$$-5 < p \leq -2$$

(b) Write down all the possible values of p .

.....
(2)

(c) Solve $5y - 2 < 18$

.....
(2)

(Total 5 marks)

9. There are 9 counters in a bag.
There is a number on each counter.

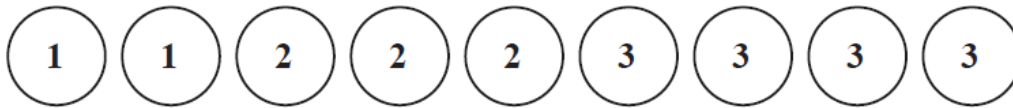

Kal takes at random 3 counters from the bag.

He adds together the numbers on the 3 counters to get his Total.

Work out the probability that his Total is 6.

.....
(Total 5 marks)

10. The highest common factor (HCF) of 140 and x is 20.

The lowest common multiple (LCM) of 140 and x is 420.

Find the value of x .

$x = \dots\dots\dots$

(Total 2 marks)

11. A number is decreased by 15%.
The result is 323

What was the original number?

$\dots\dots\dots$

(Total 3 marks)

12. Each student in a group of 32 students was asked the following question.

“Do you have a desktop computer (D), a laptop (L) or a tablet (T)?”

Their answers showed that

- 19 students have a desktop computer
- 17 students have a laptop
- 16 students have a tablet
- 9 students have both a desktop computer and a laptop
- 11 students have both a desktop computer and a tablet
- 7 students have both a laptop and a tablet
- 5 students have all three.

(a) Using this information, complete the Venn diagram to show the number of students in each appropriate subset.

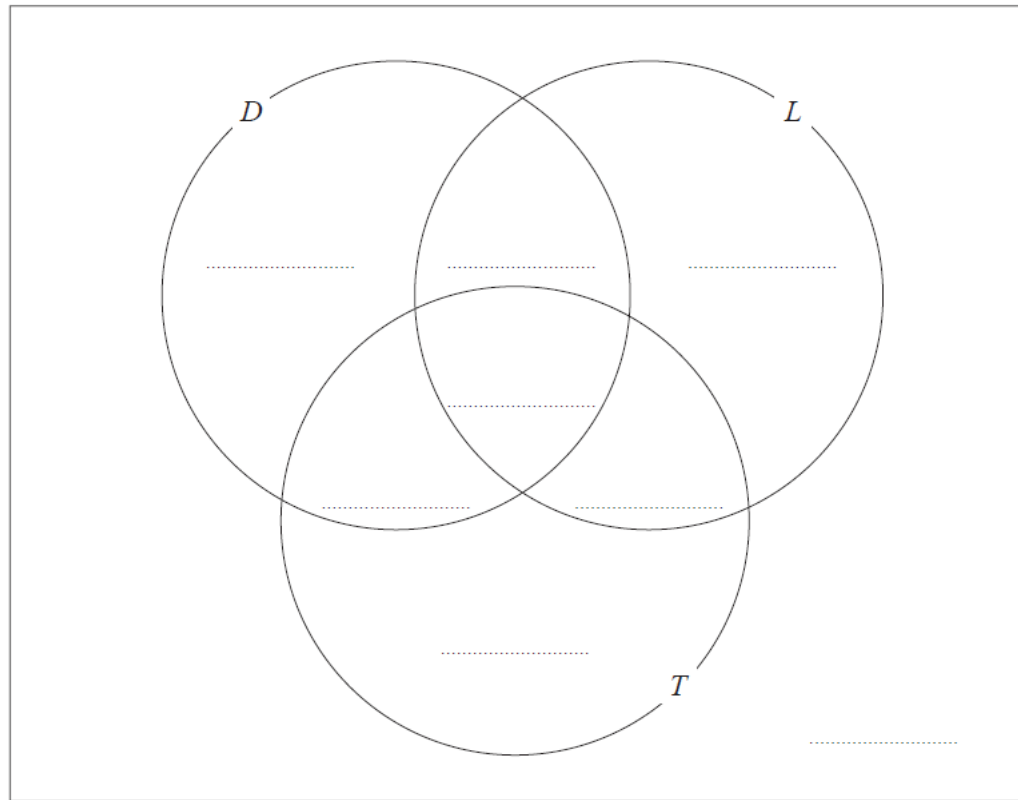

(3)

One of the students with both a desktop computer and a laptop is chosen at random.

(b) Find the probability that this student also has a tablet.

.....
(1)

(Total 4 marks)

13. The function f is defined as

$$f(x) = \frac{x-6}{2}$$

(a) Find $f(8)$.

.....
(1)

(b) Express the inverse function f^{-1} in the form $f^{-1}(x) = \dots$

$f^{-1}(x) = \dots$
(2)

The function g is defined as

$$g(x) = \sqrt{x-4}$$

(c) Express the function gf in the form $gf(x) = \dots$
Give your answer as simply as possible.

$gf(x) = \dots$
(2)

(Total 5 marks)

14. The diagram shows a prism.

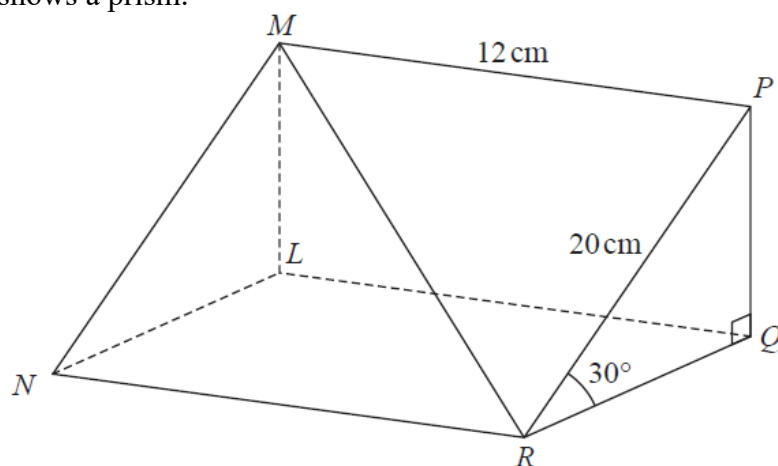

Diagram **NOT** accurately drawn

Triangle PQR is a cross section of the prism.

- $PR = 20$ cm
- $MP = 12$ cm
- Angle $PRQ = 30^\circ$
- Angle $PQR = 90^\circ$

Calculate the size of the angle that the line MR makes with the plane $RQLN$.
Give your answer correct to 1 decimal place.

.....°

(Total 5 marks)

15. A scientist is studying some rabbits.
The rabbits have a disease that kills the rabbits.

A population of 160 of these rabbits was reduced to 90 rabbits in two days.
The rabbit population is decreasing exponentially.

Work out how many of the 160 rabbits will still be alive at the end of 7 days.

.....
(Total 5 marks)

16.

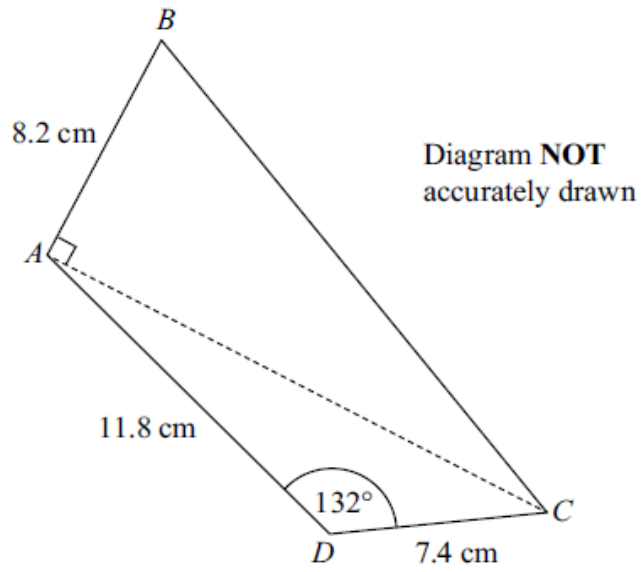

Work out the area of the quadrilateral $ABCD$.
Give your answer correct to 3 significant figures.

..... cm^2

(Total 6 marks)

17. $y = at^2 - 2at$

$$x = 2a\sqrt{t}$$

Express y in terms of x and a .

Give your answer in the form $y = \frac{x^p}{ma^3} - \frac{x^q}{na}$, where p, q, m and n are integers.

.....
(Total 4 marks)

18. The histogram shows information about the lifetime of some electrical components.

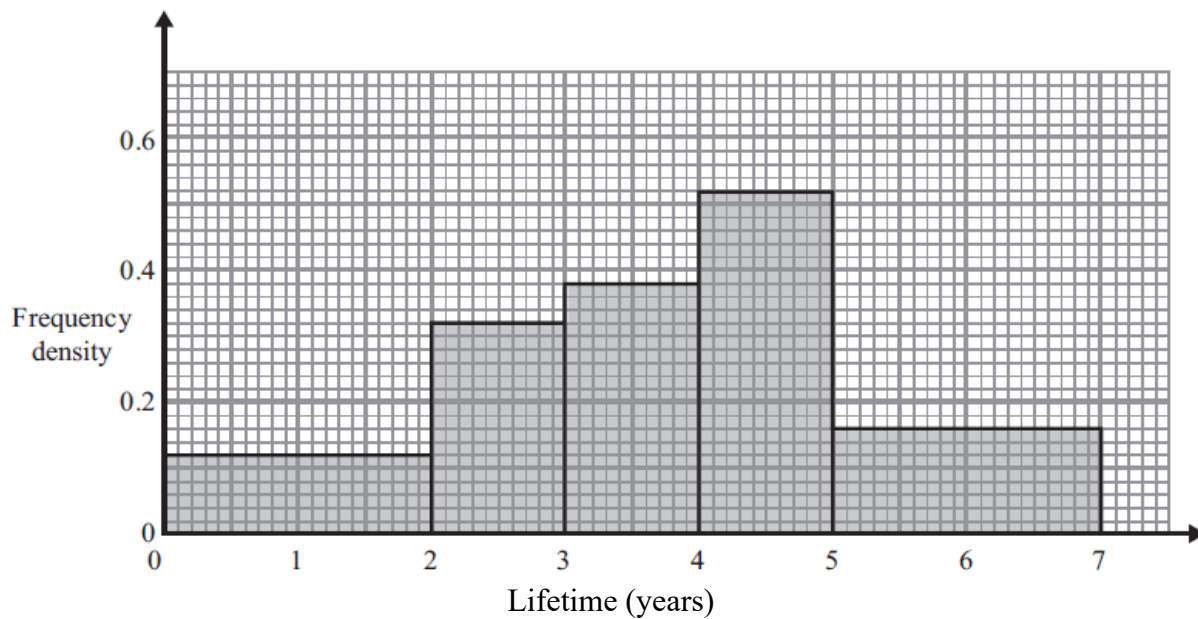

Work out the proportion of the components with a lifetime of between 1 and 6 years.

.....
(Total 4 marks)

19.

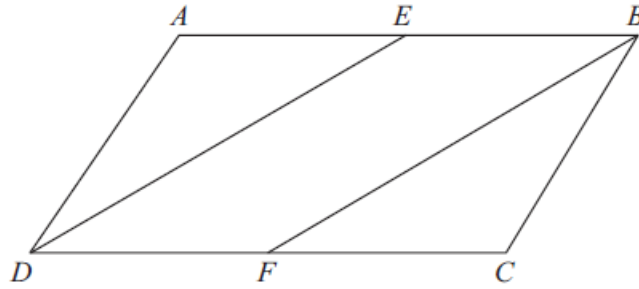

$ABCD$ is a parallelogram.

E is the midpoint of AB .

F is the midpoint of DC .

(a) Prove that triangle AED is congruent to triangle CFB .

(3)

(b) Hence, prove that $DE = FB$

(1)

(Total 4 marks)

TOTAL FOR PAPER IS 80 MARKS