

GCSE Mathematics

Practice Tests: Set 13

Paper 2H/3H (Calculator)

Time: 1 hour 30 minutes

You should have: Ruler graduated in centimetres and millimetres, protractor, pair of compasses, pen, HB pencil, eraser, calculator. Tracing paper may be used.

Instructions

- Use **black** ink or ball-point pen.
- **Fill in the boxes** at the top of this page with your name, centre number and candidate number.
- Answer **all** questions.
- Answer the questions in the spaces provided – *there may be more space than you need.*
- **Calculators may not be used.**
- Diagrams are NOT accurately drawn, unless otherwise indicated.
- You must **show all your working out.**



Information

- The total mark for this paper is 80
- The marks for **each** question are shown in brackets – *use this as a guide as to how much time to spend on each question.*

Advice

- Read each question carefully before you start to answer it.
- Keep an eye on the time.
- Try to answer every question.
- Check your answers if you have time at the end.

Answer ALL questions.

Write your answers in the spaces provided.

You must write down all the stages in your working.

- 1** The diagram shows a rectangle and a diagonal of the rectangle.

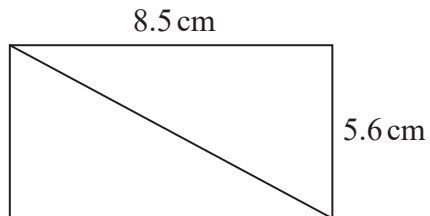

Diagram **NOT**
accurately drawn

Work out the length of the diagonal of the rectangle.
Give your answer correct to 1 decimal place.

..... cm

(Total for Question 1 is 3 marks)

- 2 A plane takes 3 hours 36 minutes to fly from the Cayman Islands to New York.
The plane flies a distance of 2470 km.

Work out the average speed of the plane in km/h.
Give your answer correct to the nearest whole number.

..... km/h

(Total for Question 2 is 3 marks)

3 The diagram shows a box in the shape of a cuboid.

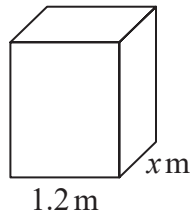

Diagram **NOT**
accurately drawn

The box is put on a table.

The face of the box in contact with the table has length 1.2 metres and width x metres.

The force exerted by the box on the table is 27 newtons.

The pressure on the table due to the box is 30 newtons/m²

$$\text{pressure} = \frac{\text{force}}{\text{area}}$$

Work out the value of x .

$x = \dots\dots\dots$

(Total for Question 3 is 3 marks)

- 4 Betsy was given £75 for her birthday.
She saved some of the money and spent the rest on a T-shirt and a bag.
Betsy saved 40% of the £75
She spent £12 more on the bag than she spent on the T-shirt.
Work out how much Betsy spent on the bag.

£.....

(Total for Question 4 is 4 marks)

5 The diagram shows two right-angled triangles, DEF and EFG .

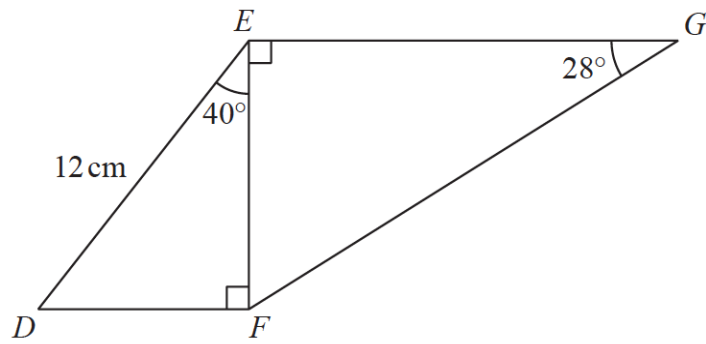

Diagram **NOT** accurately drawn

Work out the length of EG .
Give your answer correct to 3 significant figures.

..... cm

(Total for Question 5 is 4 marks)

- 6 Hamish buys a new car for £20 000
The car depreciates in value by 19% each year.
Work out the value of the car at the end of 3 years.
Give your answer to the nearest £.

£.....

(Total for Question 6 is 3 marks)

7 The diagram shows Yuen's garden.

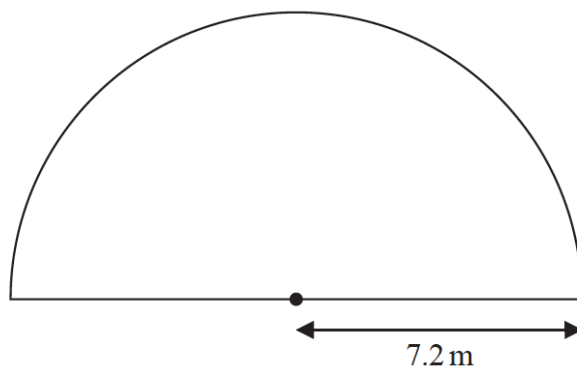

Diagram **NOT** accurately drawn

The garden is in the shape of a semicircle of radius 7.2 m.
Yuen is going to cover his garden with grass seed.

Yuen has 12 boxes of grass seed.
Each box of grass seed contains enough seed to cover 6 m^2 of the garden.

Has Yuen enough grass seed for his garden?
Show your working clearly.

(Total for Question 7 is 3 marks)

8 The table shows information about the surface area of each of the world's oceans.

Ocean	Surface area in square kilometres
Pacific	1.56×10^8
Indian	6.86×10^7
Southern	2.03×10^7
Arctic	1.41×10^7
Atlantic	1.06×10^8

- (a) Work out the difference, in square kilometres, between the surface area of the Atlantic Ocean and the surface area of the Indian Ocean.
Give your answer in standard form.

..... square kilometres
(2)

The surface area of the Pacific Ocean is k times the surface area of the Arctic Ocean.

- (b) Work out the value of k .
Give your answer correct to the nearest whole number.

$k =$
(1)

(Total for Question 8 is 3 marks)

- 9 5 children are playing on a trampoline.
The mean weight of the 5 children is 28 kg.
2 of the children get off the trampoline.
The mean weight of these 2 children is 26.5 kg.

Work out the mean weight of the 3 children who remain on the trampoline.

..... kg

(Total for Question 9 is 3 marks)

- 10** The table gives information about the amount of money, in £, that Fiona spent in a grocery store each week during 2019

Amount spent (£x)	Frequency
$0 \leq x < 20$	5
$20 \leq x < 40$	11
$40 \leq x < 60$	8
$60 \leq x < 80$	19
$80 \leq x < 100$	9

Work out an estimate for the total amount of money that Fiona spent in the grocery store during 2019

£.....

(Total for Question 10 is 3 marks)

- 11** In a sale, the normal price of a hat is reduced by 15%
The sale price of the hat is 20.40 euros.
Work out the normal price of the hat.

..... euros

(Total for Question 11 is 3 marks)

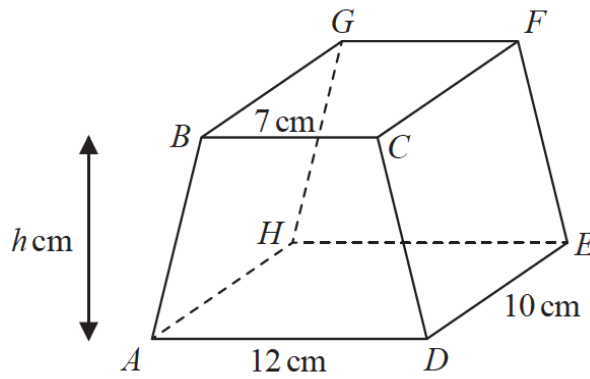

Diagram **NOT**
accurately drawn

The diagram shows a prism $ABCDEFGH$ in which $ABCD$ is a trapezium with BC parallel to AD and $CDEF$ is a rectangle.

$$BC = 7 \text{ cm} \quad AD = 12 \text{ cm} \quad DE = 10 \text{ cm}$$

The height of trapezium $ABCD$ is h cm

The volume of the prism is 608 cm^3

Work out the value of h .

$$h = \dots\dots\dots$$

(Total for Question 12 is 3 marks)

- 13 (a) Solve $\frac{4-3x}{5} - \frac{3x-5}{2} = -3$
Show clear algebraic working.

$x = \dots\dots\dots$ (3)

- (b) Solve the inequality $5y^2 - 17y \leq 40$

$\dots\dots\dots$ (3)

(Total for Question 13 is 6 marks)

- 14 Pablo made a solid gold statue.
He melted down some gold blocks and used the gold to make the statue.
Each block of gold was a cuboid, as shown below.

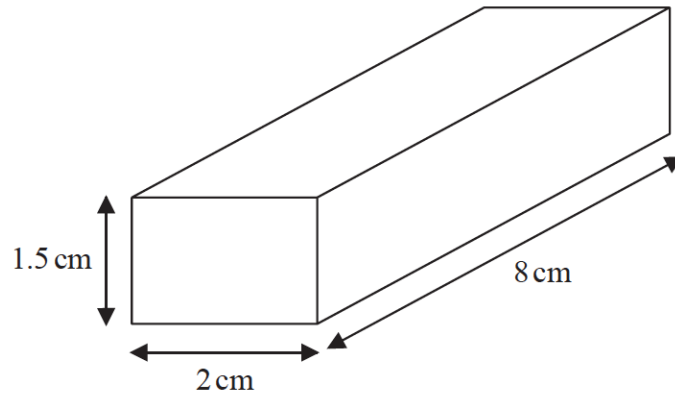

Diagram **NOT**
accurately drawn

The mass of the statue is 5.73 kg.
The density of gold is 19.32 g/cm^3

Work out the least number of gold blocks Pablo melted down in order to make the statue.
Show your working clearly.

.....
(Total for Question 14 is 5 marks)

15 Steffi is going to play one game of tennis and one game of chess.

The probability that she will win the game of tennis is 0.6

The probability that she will win **both** games is 0.42

Work out the probability that she will **not** win either game.

.....
(Total for Question 15 is 4 marks)

- 16 The diagram shows two congruent isosceles triangles and parts of two congruent regular polygons, **X** and **Y**.

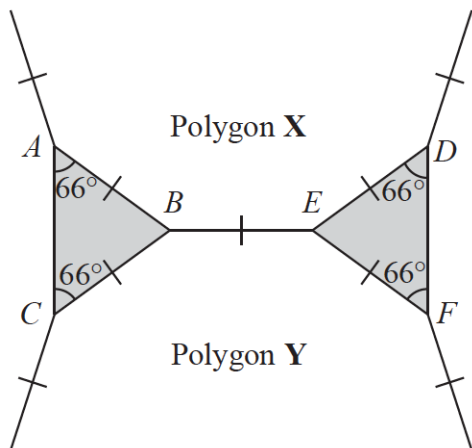

Diagram **NOT** accurately drawn

The two regular polygons each have n sides.

Work out the value of n .

$n = \dots\dots\dots$

(Total for Question 16 is 3 marks)

17 Use algebra to show that $0.5\dot{7}\dot{2} = \frac{63}{110}$

(2)

(Total for Question 17 is 2 marks)

TURN OIVER FOR QUESTION 18

- 18** Cody has two bags of counters, bag **A** and bag **B**.
Each of the counters has either an odd number or an even number written on it.
There are 10 counters in bag **A** and 7 of these counters have an **odd** number written on them.
There are 12 counters in bag **B** and 7 of these counters have an **odd** number written on them.
Cody is going to take at random a counter from bag **A** and a counter from bag **B**.

(a) Complete the probability tree diagram.

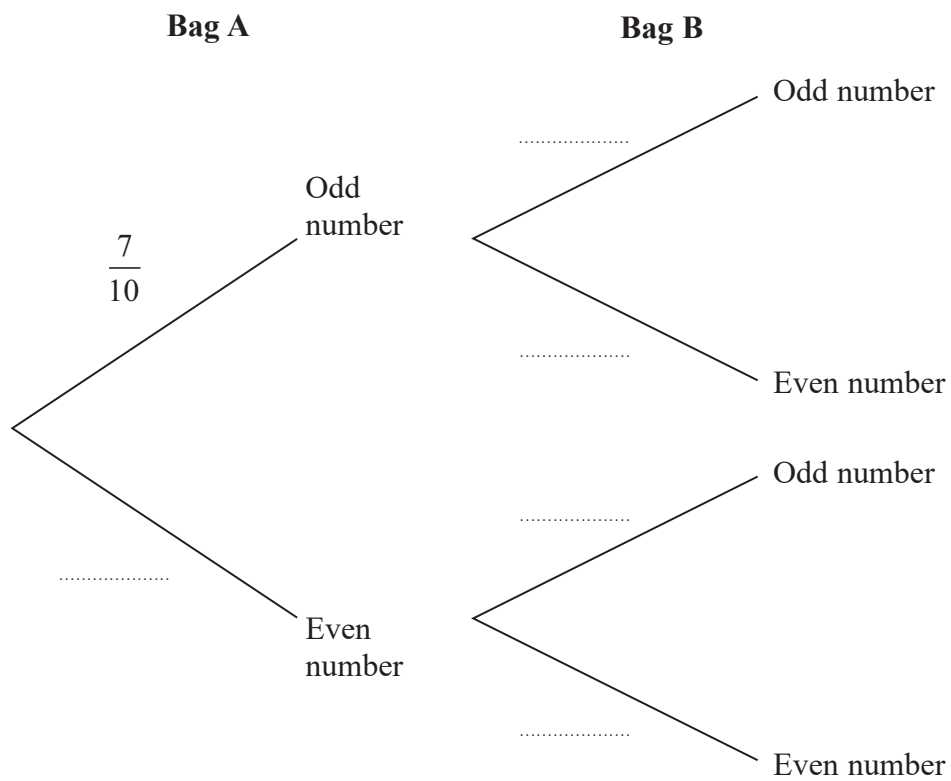

(2)

- (b) Calculate the probability that the total of the numbers on the two counters will be an odd number.

.....
(3)

Harriet also has a bag of counters.

Each of her counters also has either an odd number or an even number written on it.

Harriet is going to take at random a counter from her bag of counters.

The probability that the number on each of Cody's two counters **and** the number on

Harriet's counter will all be even is $\frac{3}{100}$

- (c) Find the least number of counters that Harriet has in her bag.
Show your working clearly.

.....
(3)

(Total for Question 18 is 8 marks)

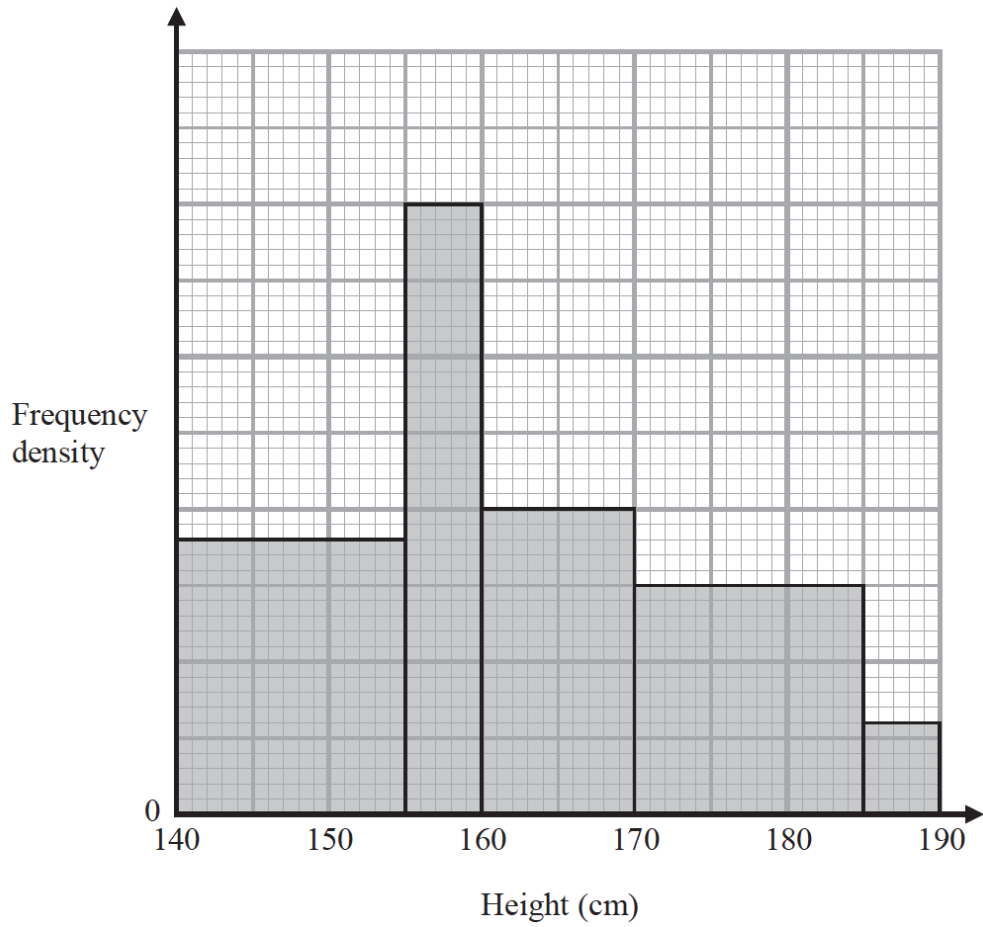

The histogram gives information about the heights of all the Year 11 students at a school.
 There are 160 students in Year 11 with a height between 155 cm and 170 cm.
 Work out the total number of students in Year 11 at the school.

.....
(Total for Question 19 is 4 marks)

20 The diagram shows two similar vases, **A** and **B**.

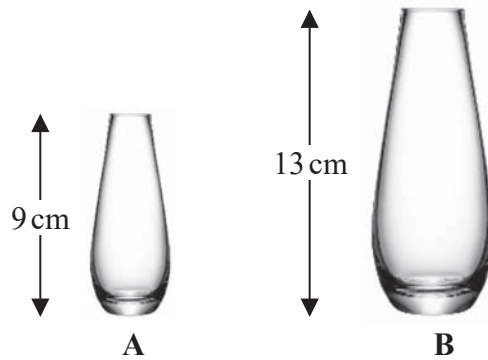

Diagram **NOT** accurately drawn

The height of vase **A** is 9 cm and the height of vase **B** is 13 cm.

Given that

$$\text{surface area of vase A} + \text{surface area of vase B} = 1800 \text{ cm}^2$$

calculate the surface area of vase **A**.

..... cm²

(Total for Question 20 is 4 marks)

21 The diagram shows the prism $ABCDEF$ with cross section triangle ABC .

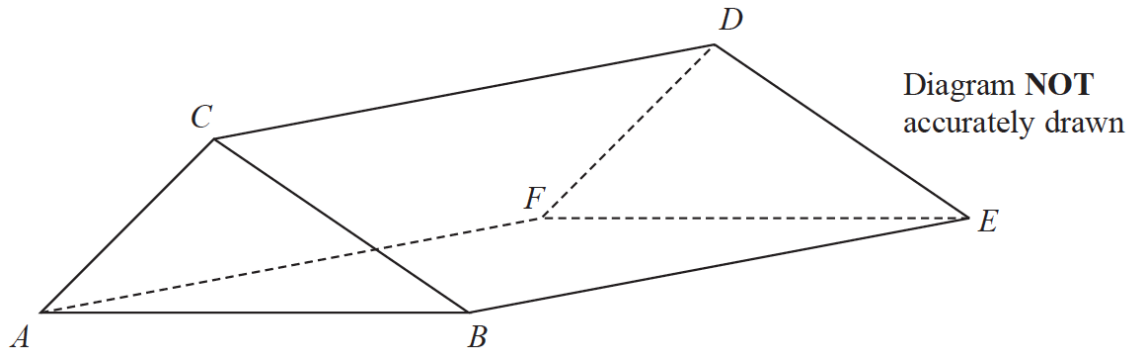

Angle $BEC = 40^\circ$ and angle ACB is obtuse.
 $AC = 6$ cm and $CE = 13$ cm

The area of triangle ABC is 22 cm²

Calculate the length of AB .
 Give your answer correct to one decimal place.

..... cm

(Total for Question 21 is 6 marks)

TOTAL FOR PAPER IS 80 MARKS